

Custom Protocol Creation Guide

OCTO MK2/PIXELATOR MINI

A convenient and time-saving DIY solution for user to control pixel fixtures (two criteria apply).

INTRODUCTION

OCTO MK2/PIXELATOR MINI features more than 20 pixel output protocols in the device. In the event of missing protocol, this new feature in OCTO MK2/PIXELATOR MINI allows user to create custom protocol for the desired pixel fixture anytime (*two key criteria apply*) without having to submit support request for new firmware.

Within this document is the setup instruction for custom pixel output protocols creation, alongside the guide on criteria verification.

The creation requires user to first match the desired pixel protocol to the existing protocols (*as per two key criteria*). Next select compatible pixel protocol offered in dropdown list followed by adjustment of pixel fixture's data voltage timing (*according to manufacturer datasheet*) on OCTO MK2/PIXELATOR MINI's web interface where applicable.

Table 1 below provides an overview of the step-by-step guide:

GUIDE OVERVIEW	
Step 1	Match your pixel tape to the existing protocol by verifying 2 key criteria.
Step 2	Enable custom protocol in Settings page on web interface.
Step 3	Set custom voltage timing.

Table 1 - Guide Overview

SETUP REQUIREMENTS

To create custom protocol, the followings are required:

1. Datasheet of desired pixel fixture is required to verify key criteria for eligibility and to obtain information for creation. Reach out to dealer or fixture manufacturer for datasheet.
2. Device such as computer or smart phone with Internet browser app (such as Google Chrome) that is on the same local network to OCTO MK2/PIXELATOR MINI.
3. OCTO MK2/PIXELATOR MINI IP address – this can be DHCP or static IP address depending on your network settings. Discoverable with ENTTEC EMU app.

Note:

This custom protocol feature only available from OCTO V4.0 onward and PIXELATOR MINI V2.0 onward. Please see latest User Manual from website for revision history for the appropriate firmware version of your device.

STEP-BY-STEP GUIDE TO CUSTOM PROTOCOL CREATION

Step 1: Match your pixel tape to the existing protocol by verifying 2 key criteria

1.1 **Data Structure** and **Transmission Method** are the 2 key criteria in the Custom Protocol Creation feature which supports: 4 types of Data Structure and 2 types of Transmission Method.

2 Key Criteria	
Data Structure	Transmission Method
24bit (8bit x 3 channels)	No additional bits: D1-D2...Dn Additional 64bit constant value: C1-C2-D1-D2....Dn
32bit (8bit x 4 channels)	
48bit (16bit x 3 channels)	
64bit (16bit x 4 channels)	

Table 2 - Table of 2 Key Criteria

1.2 Refer to [Appendix](#) section to learn more on how to verify the 2 key criteria of your desired protocol.

1.3 Highlighted in Table 3 below are 3 matching LED protocols recommended for use during protocol creation. (See Step 2.2)

For example, if your desired pixel fixture's Data Structure is 24bit and the Transmission Method is D1-D2...Dn with no additional bits, WS2812B is the recommended protocol to continue in Step 2.2.

Data Structure \ Transmission Method	24bit 8bit x 3 channels	32bit 8bit x 4 channels	48bit 16bit x 3 channels	64bit 16bit x 4channels
No additional bits D1-D2...Dn	WS2812B		UCS8903-16bit	
Additional 64bit constant value C1-C2-D1-D2....Dn	Not supported	TM1814	Not supported	Not supported

Table 3 - Table of the nominated protocol that matches your pixel fixture by verifying Data Structure and Transmission Method

Step 2: Enable custom protocol in Settings page on web interface

2.1. Access OCTO MK2/PIXELATOR MINI web interface

- 2.1.1. ENTTEC recommend Google Chrome as web browser to access OCTO MK2/PIXELATOR MINI web interface.
- 2.1.2. Free ENTTEC app, EMU can be used to retrieve OCTO MK2/PIXELATOR MINI IP address. See ENTTEC website www.enttec.com to download app.
- 2.1.3. After entering IP address of OCTO MK2/PIXELATOR MINI, user will land on Home page of OCTO MK2/PIXELATOR MINI.

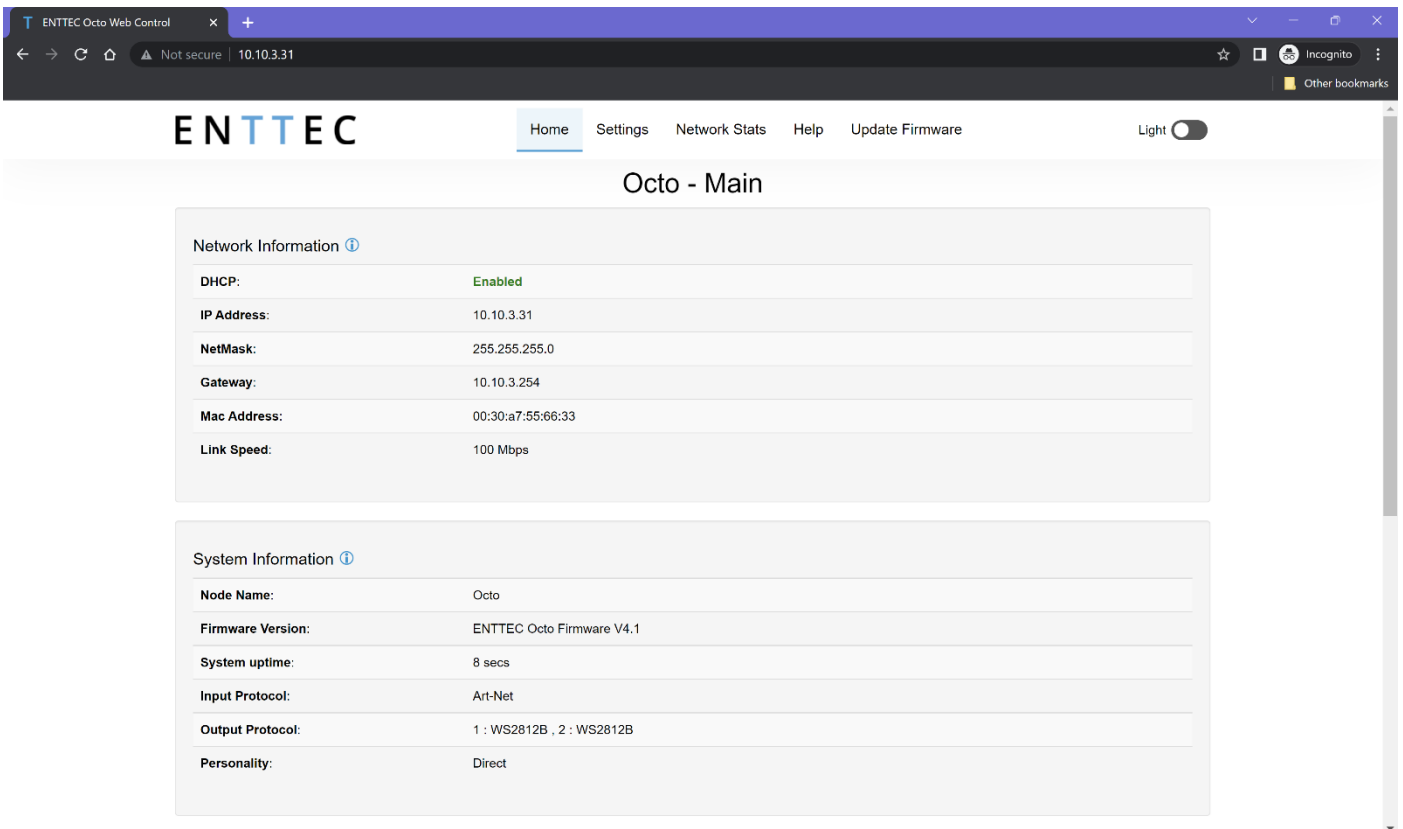

Figure 1 – Example of OCTO MK2 Home Page

Example of OCTO MK2 homepage in Figure 1 indicates IP address 10.10.3.31, which was assigned by DHCP server. For out of box OCTO MK2/PIXELATOR MINI that is connected directly to a computer (no DHCP server), the default IP address will be 192.168.0.10.

See OCTO MK2/PIXELATOR MINI User Manual ‘Networking’ section for more information.

2.2. Navigate to Settings page – Output Setting

Go to the output where the desired pixel fixture is connected to. *Pick pixel protocol from dropdown list that shares same data structure and transmission method* verified in Step 1.3.

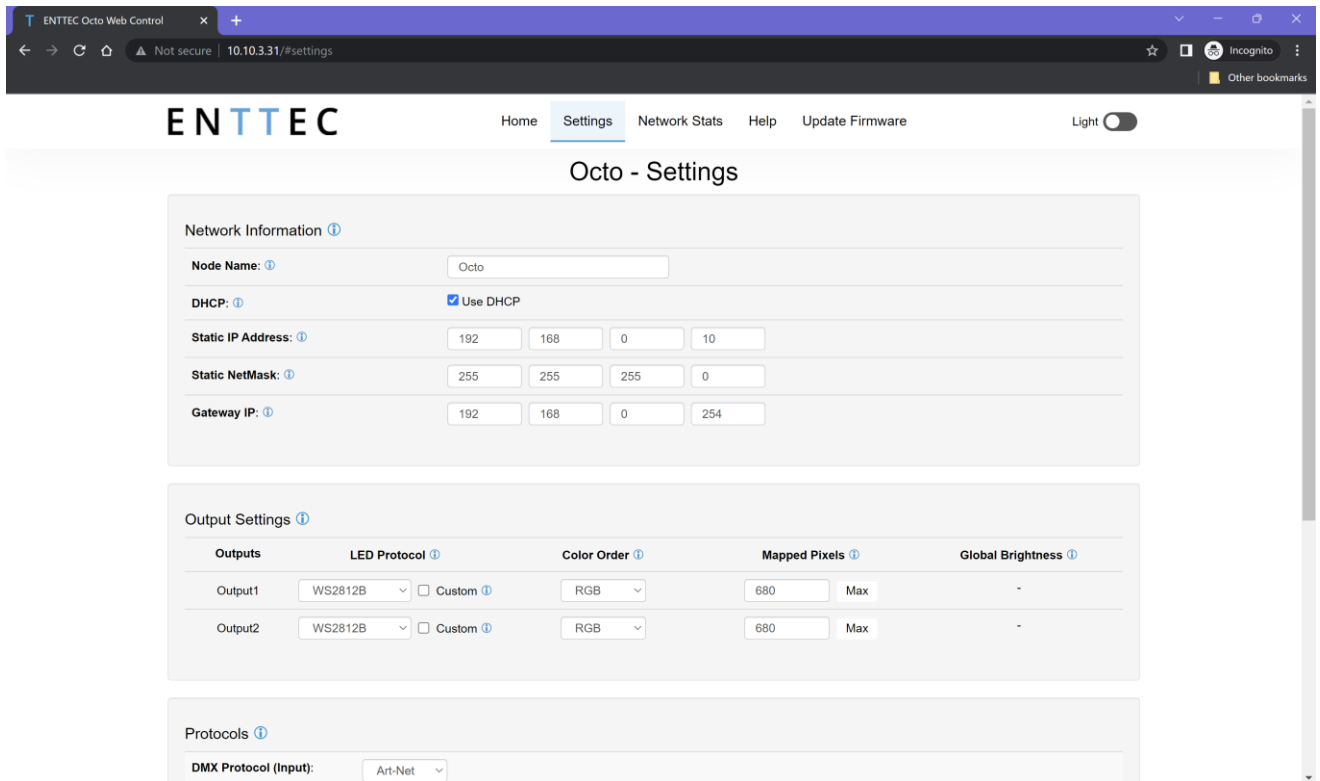

Figure 2 – Example of OCTO MK2 Settings Page

2.3. Enable Custom protocol

Enable 'Custom' tickbox to access data voltage timing setup. Untick to disable custom protocol.

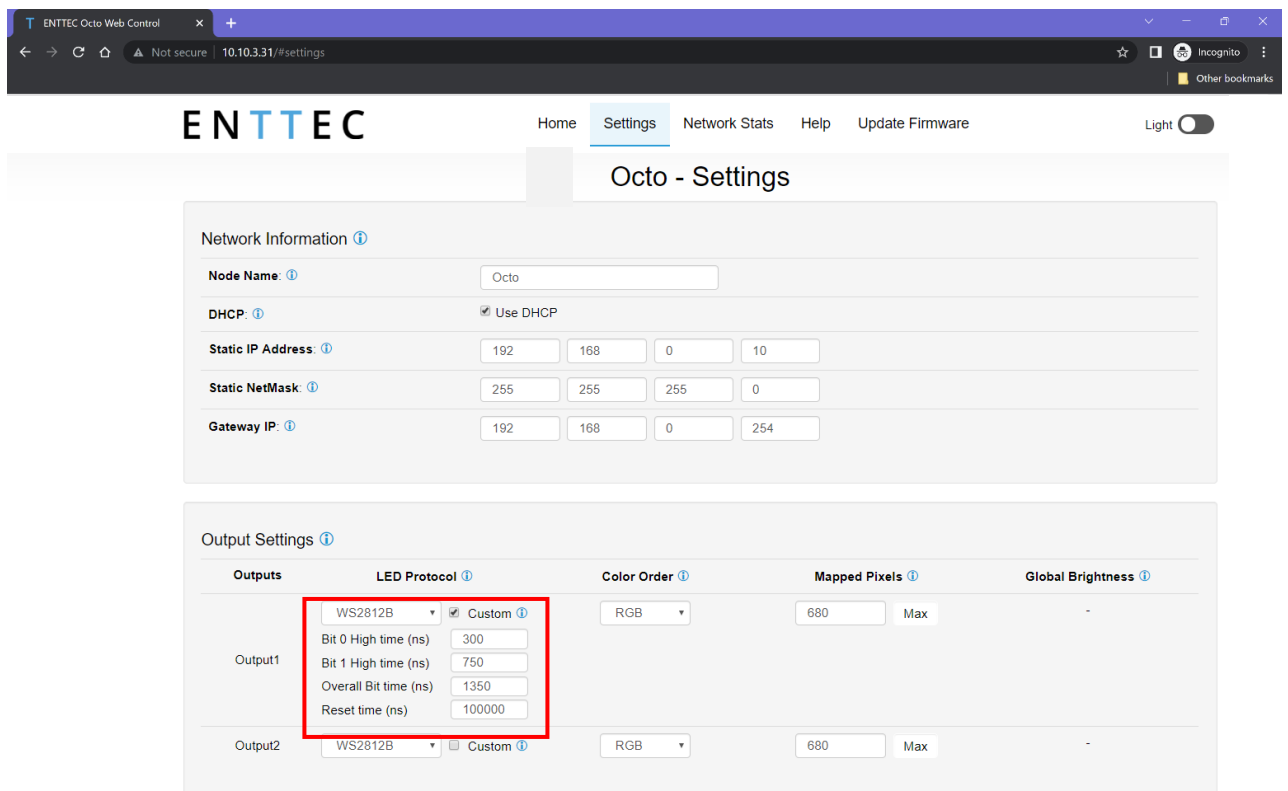

Figure 3 -Example of OCTO MK2 Custom field after enabling 'Custom' tick box

Step 3: Set custom voltage timing

3.1. OCTO MK2/PIXELATOR MINI requires 4 inputs to complete data voltage timing adjustment:

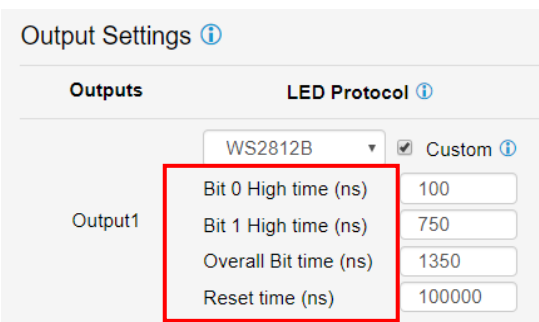

Figure 4 - Custom Voltage Timing values

Voltage Timing Definition	
Bit 0 High Time (T0H)	The voltage high time required for code 0.
Bit 1 High Time (T1H)	The voltage high time required for code 1.
Overall Bit Time:	The total voltage time for a single bit. Lower limit = T0H+T0L Upper limit = T1H+T1L
Reset Time	The total voltage low time required to reset the data transmission between each data batch.

Table 4 - Definition of Voltage Timing values

3.2. **Datasheet - Data voltage timing info Example:**

From WB2818B's datasheet

Locate 'Sequence Time' table (Figure 5) in WB2818B's datasheet for voltage timing range.

Fill the voltage timing range in the custom field in Output Settings (Figure 6).

Sequence Time		
T0H	0-code, High-level time	220ns-380ns
T1H	1-code, High-level time	580ns-1µs
T0L	0-code, Low-level time	580ns-1µs
T1L	1-code, Low-level time	580ns-1µs
RES	Frame unit, Low-level time	> 280µs

Figure 5 - Voltage Timing from WB2818B Datasheet

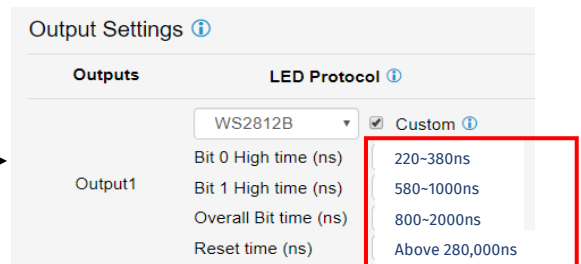

Figure 6 - Datasheet information interpreted into LED Protocol's custom field

IMPORTANT

- ENTTEC recommend taking median value of the range for start.
- User will have to SAVE settings for modified value to take effect.
- Fine adjustment of value required, follow by actual output test to optimise custom protocol for pixel fixture control.
- ENTTEC recommend a trial run on actual setup before finalising custom protocol setup
- Typical issue of incorrect setup includes and not limited to failure to light up, output flickering.

CONCLUSION

This guide demonstrated on how to set up custom protocol in OCTO MK2/PIXELATOR MINI, alongside the technical knowledge in Appendix on how to verify the 2 key criteria from the datasheet of your desired pixel fixtures.

By following these steps, user can create a custom pixel protocol that is not in drop-down list anytime without waiting for technical support or new firmware release. However, if you still have questions or have difficulty finding right information, reach out to our friendly support team in the local offices.

APPENDIX

Two key criteria for custom pixel protocol

For custom output protocol creation, the desired pixel fixture must meet two key criteria:

- A. Data structure
- B. Data Transmission Method

2 Key Criteria	
Data Structure	Transmission Method
24bit (8bit x 3 channels)	No additional bits: D1-D2...Dn Additional 64bit constant value: C1-C2-D1-D2....Dn
32bit (8bit x 4 channels)	
48bit (16bit x 3 channels)	
64bit (16bit x 4 channels)	

Table 5 - Table of 2 Key Criteria

A. Data Structure

A.1. This is how pixel data are formatted. There are 2 sub-compositions.

- Data bit: 8bit or 16bit
- Channel number: 3 channels - RGB or 4 channels – RGBW (colour order doesn't matter).

A.2. OCTO MK2/PIXELATOR MINI support 4 combinations:

Data Structure			
Channel		3 channels (RGB)	4 channels (RGBW)
Data Bit			
8bit		24bit	32bit
16bit		48bit	64bit

Table 6 - Table of Data Structure

A.3. **Datasheet - Data Structure info example:**

A.3.1. **WB2812B's datasheet (24-bit):**

Figure 7 (adapted from datasheet) indicates composition of 24bit data with G7-G0, R7-B0, and B7-B0. As a result, the Data Structure of WB2812B is made of 8bit of G (green), B (Blue) and R (Red) each = 8bit x 3 channels (GRB) = 24bit.

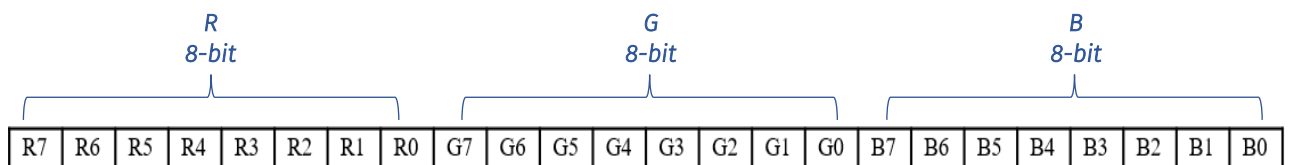

Figure 7 – Data structure information from WB2812B Datasheet

A.3.2. TM1814's datasheet (32-bit):

Figure 8 (adapted from datasheet) indicates composition of 32bit: W7-W0, R7-R0, G7-G0 and B7-B0. As a result, the Data Structure of TM1814 is made of 8bit of W (White), R (Red), G (Green) and B (Blue) each = 8bit x 4 channels (WRGB) = 32-bit.

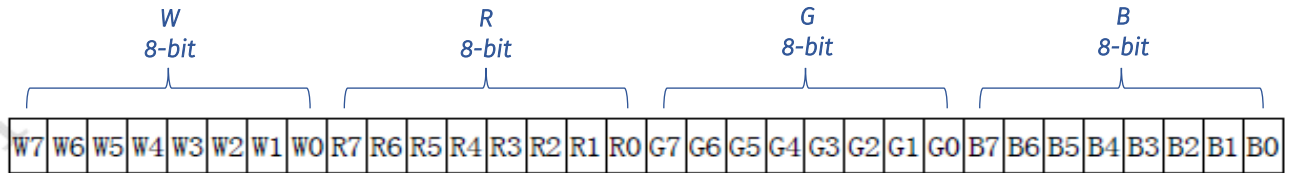

Figure 8 - Data structure information from TM1814 Datasheet

A.3.3. UCS8903's datasheet (48-bit):

Figure 9 (adapted from datasheet) indicates composition of 48bit: R15-R0, G15-G0 and B15-B0. As a result, the Data Structure of UCS8903 is made of 16bit of R (Red), G (Green) and B (Blue) each = 16bit x 3 channels (RGB) = 48-bit.

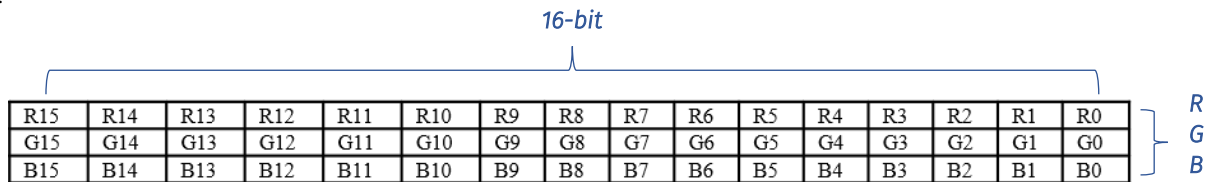

Figure 9 - Data structure information from UCS8903 Datasheet

A.3.4. UCS8904B's datasheet (64-bit):

In the event when there is lack of pictorial depiction of Data Structure in datasheet, product description will indicate information to help with structure verification. In UCS8904B datasheet description such as:

“4 channels”, which means RGBW.

“65536 levels of true gray” indicates numerical formula equivalent to 16^4 - which means 16bit x 16bit x 16bit x 16bit

This reaches the conclusion of 16bit x 4 channels (RGBW) = 64-bits.

B. Data Transmission Method (also known as data cascade method)

B.1. This is how data are transmitted, and there are 2 main categories.

OCTO MK2/PIXELATOR MINI support both categories:

- D1-D2-D3...Dn: Data is transmitted without additional bits.
- C1-C2-D1-D2-D3...Dn: Data is transmitted with additional C1 & C2 Constant Value (64bit).

Transmission Method	
D1-D2...Dn No additional bits	C1-C2-D1-D2...Dn Additional 64bit Constant Value

Table 7- Table of Transmission Method

B.2. Datasheet – Data Transmission info Example:

B.2.1. WB2812B's datasheet (D1-D2-D3...Dn):

Figure 10 (adapted from datasheet) indicates data transmission by D1-D2-D3-D4 between pixels.

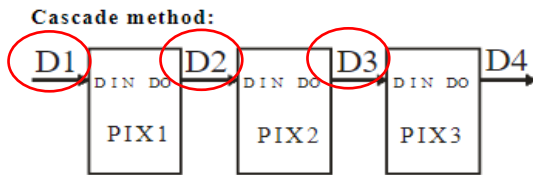

Figure 10 - Cascade Method in WB2812B Datasheet

Figure 11 (adapted from datasheet) shows each D1, D2, D3 are transmitted with data batch of 24bit (8bit x 3 channels) without additional bits on start and end of data.

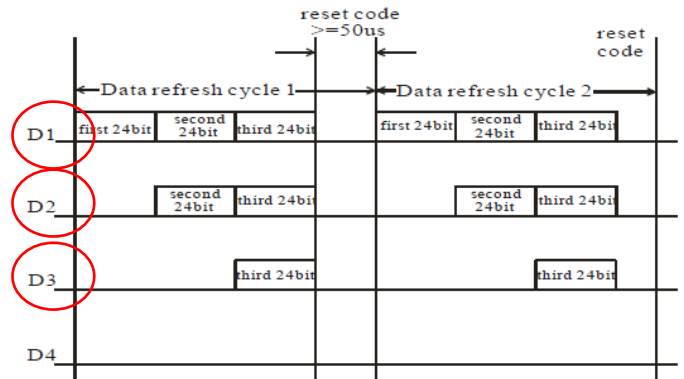

Figure 11 - Data Transmission Method in WB2812B Datasheet

Therefore, WB2812B Transmission Method is D1-D2...Dn.

B.2.2. TM1814's datasheet (C1-C2-D1-D2-D3...Dn):

Figure 12 (adapted from datasheet) indicates 'Data receiving and forwarding' with S1-S2-S3-S4 between pixel (chip)

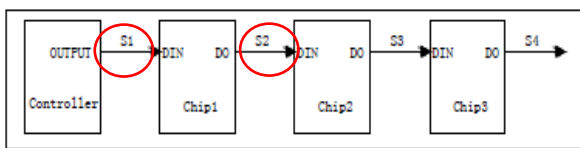

Figure 12 - Data Receiving and Forwarding in TM1814 Datasheet

Figure 13 (adapted from datasheet) shows how S1, S2, S3 are transmitted with extra C1-C2 in the front of data batch.

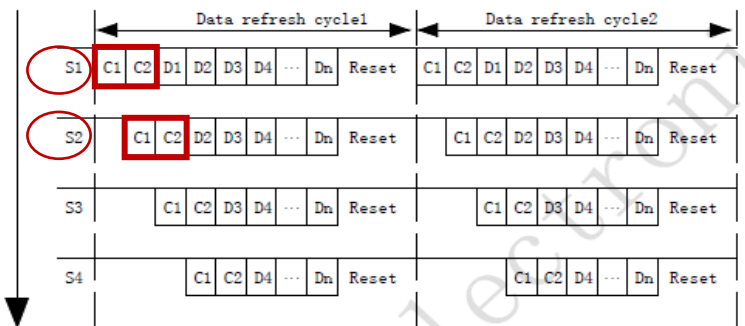

Figure 10 - Data Transmission and forwarding process in TM1814 Datasheet

Therefore, TM1814 Transmission Method is C1-C2-D1-D2-D3...Dn.

enttec.com

MELBOURNE AUS / LONDON UK / RALEIGH-DURHAM USA

Due to constant innovation, information within this document is subject to change.