

# ENTTEC

## NEON FLEX - DMX

73060

---

### INSTALLATION GUIDE



Horizontal/Vertical bendable weatherproof Neon Flex LED strip

## Contents

Safety .....	3
Electrical Safety .....	3
System Planning and Specification .....	3
Protection from Injury During Installation.....	3
Installation Safety and Guidelines .....	4
Physical Dimensions .....	5
Wiring Application.....	6
Electrical Connections .....	6
DMX Wiring Diagram.....	7
Voltage Drop.....	8
Control Channels .....	8
Mounting Installation.....	9
Servicing, Inspection & Maintenance .....	12
Cleaning.....	12
Ordering Information .....	13
Neon Flex .....	13
Neon Flex Accessories.....	13

## Safety

 Ensure you are familiarised with all key information within this guide and other relevant ENTTEC documentation before specifying, installing, or operating an ENTTEC device. If you are in any doubt about system safety, or plan to install an ENTTEC device in a configuration not covered within this guide, contact ENTTEC or your ENTTEC supplier for assistance.

**ENTTEC's return to base warranty for this product does not cover damage caused by inappropriate use, application, or modification to the product.**

## Electrical Safety



- This product must be installed in accordance with applicable national and local electrical and construction codes by a person familiar with the construction and operation of the product and the hazards involved. Failure to comply with the following installation instructions may result in death or serious injury.
- This device can be damaged by excess voltage. The installation of an overvoltage protection device on the electrical system may reduce the risk of damage.
- Provide a means of locking out AC mains power to the installation to be shut down and made it impossible to reapply accidentally.
- Before applying power to the installation, check that all power distribution equipment and cables are in perfect condition and rated for the current requirements of all connected devices and factor in overhead.
- Isolate the installation from power immediately if Neon Flex, accessories power cables or connectors is in any way damaged, defective, shows signs of overheating or is wet (if not an IP67 component).
- Adhere to the maximum length limitations for Neon Flex and accessories as specified in the guide and product documentation.
- To reduce the risk of fire or electrical faults do not exceed the ratings and limitations defined in the product datasheet or this guide.
- Do not hot swap Neon Flex or accessories.
- Shut down power to the installation during cleaning in addition to when the system is not in use.
- Always comply with local electrical and building regulations. If you have any uncertainties, seek support from a local distributor for guidance and assistance.
- This device operates on DC power and excludes an earth connection.
- The Earth wire **MUST ALWAYS** be connected.
- Always make sure that the power and data connections are connected correctly and securely.
- Do not reserve polarity when connecting from both ends.
- Always test connections with a multi-meter before applying power.
- ENTTEC recommend the use of cable ferrules when connecting non-tinned cable.

## System Planning and Specification



- Please refer to the product datasheet and installation guide to determine the light output and cable required for your installation before initiating your system design.
- For best practice keep all cable run lengths to a minimum to avoid electrical noise.
- Avoid running data cabling close to mains power or devices that emit electromagnetic noise (i.e. air conditioning units).

## Protection from Injury During Installation



- Always use suitable personal protective equipment when installing ENTTEC products.
- When installing the Neon Flex above ground level, ensure that the installation hardware and supporting structure can hold the weight of all the devices they support.
- In an overhead installation or where the Neon Flex system may cause injury if it falls. Block access below the work area and work from a stable platform whenever installing, servicing or moving the Neon Flex system.
- Once installation is completed, check that all hardware and components are securely in place and fastened to supporting structures.

## Installation Safety and Guidelines

**Always work with a plan of installation that respects all system limitations as defined within this guide and adheres to the safety information.**



- Ensure proper data flow by following the direction indicated on the Neon Flex.
- Avoid covering Neon Flex with any insulating material.
- Take care not to apply tension on the cabling while installing Neon Flex or accessories.
- Qualified personnel should perform the installation, and professional consultation is advised when unsure.



- Power connections should not be made until all installation work is complete.
- Do not install Neon Flex if the cabling is damaged.
- Verify the operating voltage and frequency compatibility before connecting Neon Flex to a power supply.
- Avoid crushing or clamping Neon Flex or accessory cabling during installation.
- Protect connections and avoid leaving them exposed or disconnected in damp or wet environments.
- Handle Neon Flex strips only when they are not energized.
- Prevent short circuits by ensuring connectors and accessory cabling are positioned safely.
- Ensure proper restraint and secure installation of Neon Flex and accessory cabling before system sign-off.
- Confirm the surface's weight-bearing capacity before attaching Neon Flex and accessories.
- For outdoor installations, employ corrosion-proof and rated fixings.
- Avoid bending Neon Flex into curves with diameters less than 80mm (3.15in).
- Maintain a minimum distance of 0.5m from combustible surfaces.
- Avoid overstressing Neon Flex cabling sections.
- Do not operate Neon Flex in temperatures exceeding 50°C (122°F).
- Ensure sufficient airflow for convection cooling of Neon Flex units.
- Avoid covering or enclosing Neon Flex without proper heat dissipation methods.
- Keep the device out of direct sunlight whenever possible for optimum operating temperature.
- Do not modify the Neon Flex system in any way.
- Use a flat and solid surface for the supporting structure.
- Verify the suitability of mounting positions and surfaces with a qualified person.
- Ensure secure installation with all necessary safety anchors.
- Avoid routing the product onto rough surfaces or sharp corners that may damage its finish.
- Do not use the product if the finish is damaged, there are loose electrical connections, or the wires are visible without insulation.
- Avoid installing the product in pools used by humans.
- Prohibit excessive pulling or bending force during installation.
- Always use the product with an electrical isolation transformer providing Safety Extra Low Voltage (SELV).
- Consider all limiting factors before finalizing the system design and adhere to the lowest applicable limit.

## Physical Dimensions

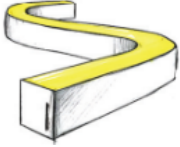
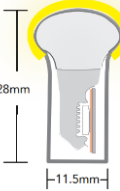
Bending	Variant	Shape	Beam Angle (degree)	Height (mm)	Width (mm)	Bending Diameter (mm)
Horizontal 	S1		120	21	11.5	80
	S2		120	16.5	16.5	150
	S3		270	28	11.5	80
Vertical 	S4		120	16.5	16.5	120
	S5		210	16.5	16.5	120

## Neon Flex

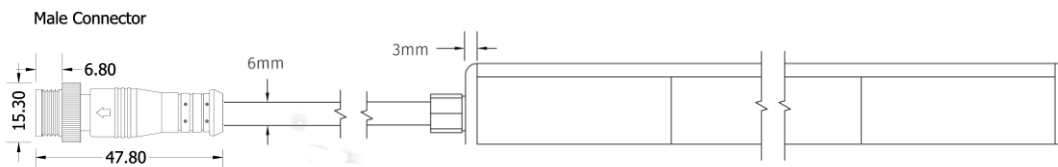

## Female Connector

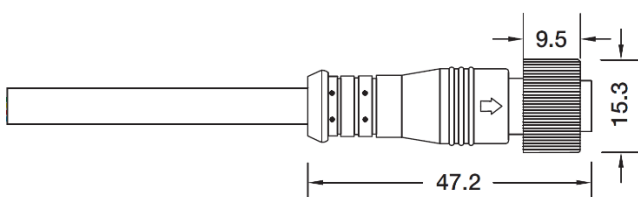

## Male Connector

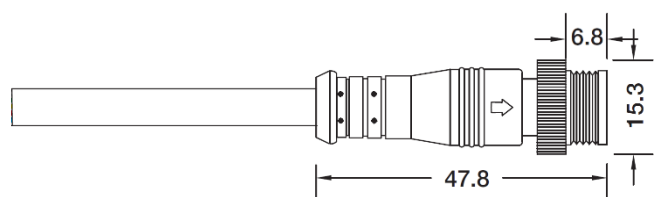

## Wiring Application

- ENTTEC offers various products to control Neon Flex, each designed for different use case scenarios and its control protocol.
- Wiring application for Auto-Addressing DMX is demonstrated as below. Key specification information and application diagrams for each system can be found in its product datasheet and user manual.
- To see the full range of ENTTEC lighting controllers, please visit [www.enttec.com](https://www.enttec.com) for the latest information.

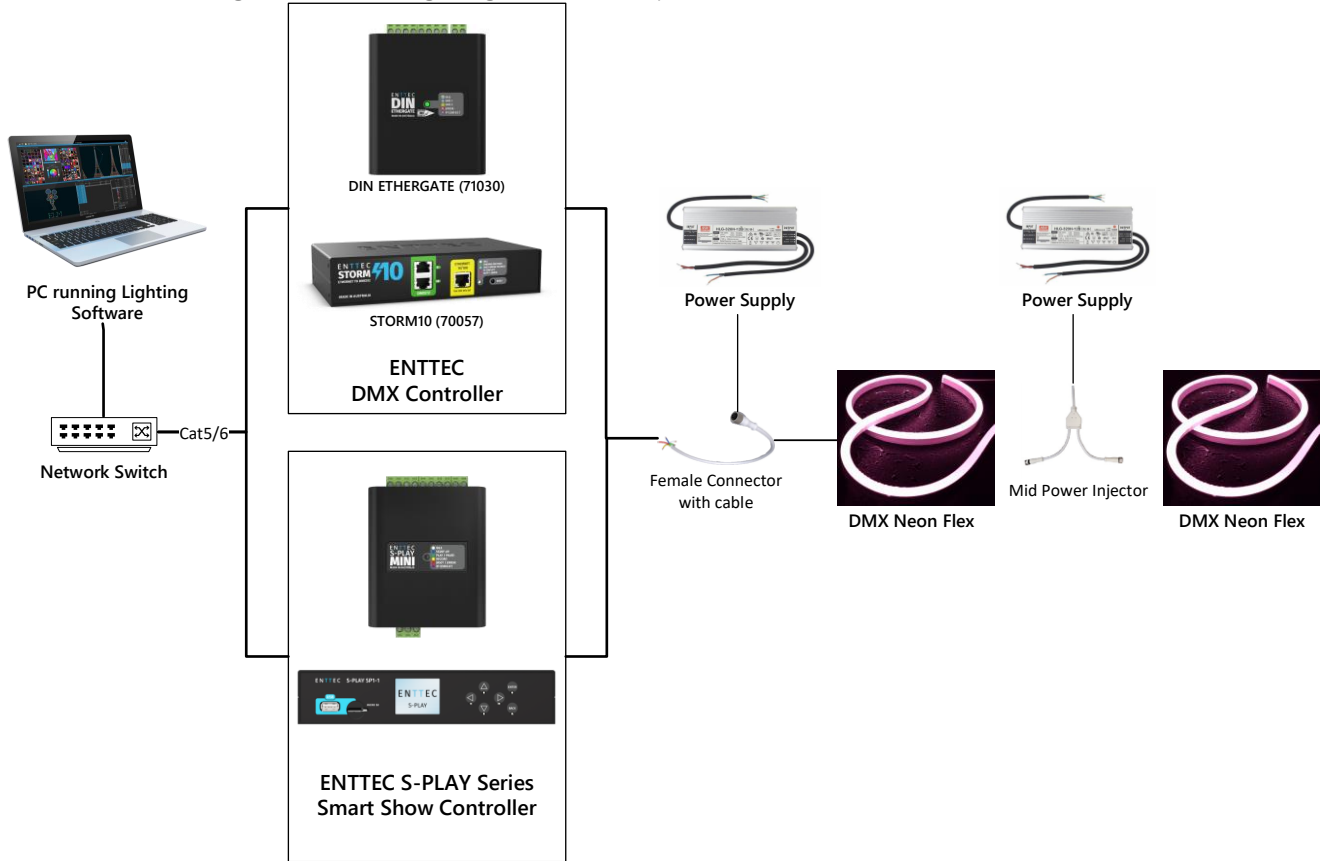

## Electrical Connections

- ENTTEC Neon Flex is a made-to-order product with the finish of the product specifically moulded to provide optimal weatherproof performance.
- Specifications including lengths of the Neon Flex, cable lengths, connector style and type are necessary before placing an order.
- Female or male connector with cable can be ordered separately in various lengths.
- It is recommended to ensure the feeder cable is long enough to reach the cable entry point of flex where connection can be made.
- Do not cut the Neon Flex and the waterproof connectors. DIY cutting of this product will void the warranty.
- Tighten the female and male connectors with pliers when installing to ensure there are no gaps.

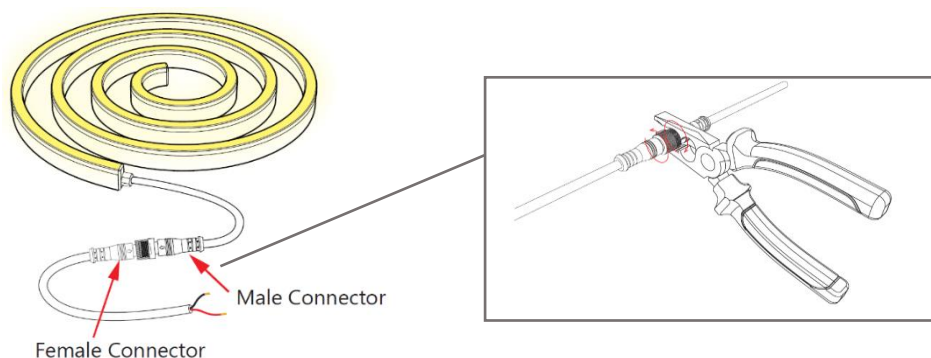

## DMX Wiring Diagram

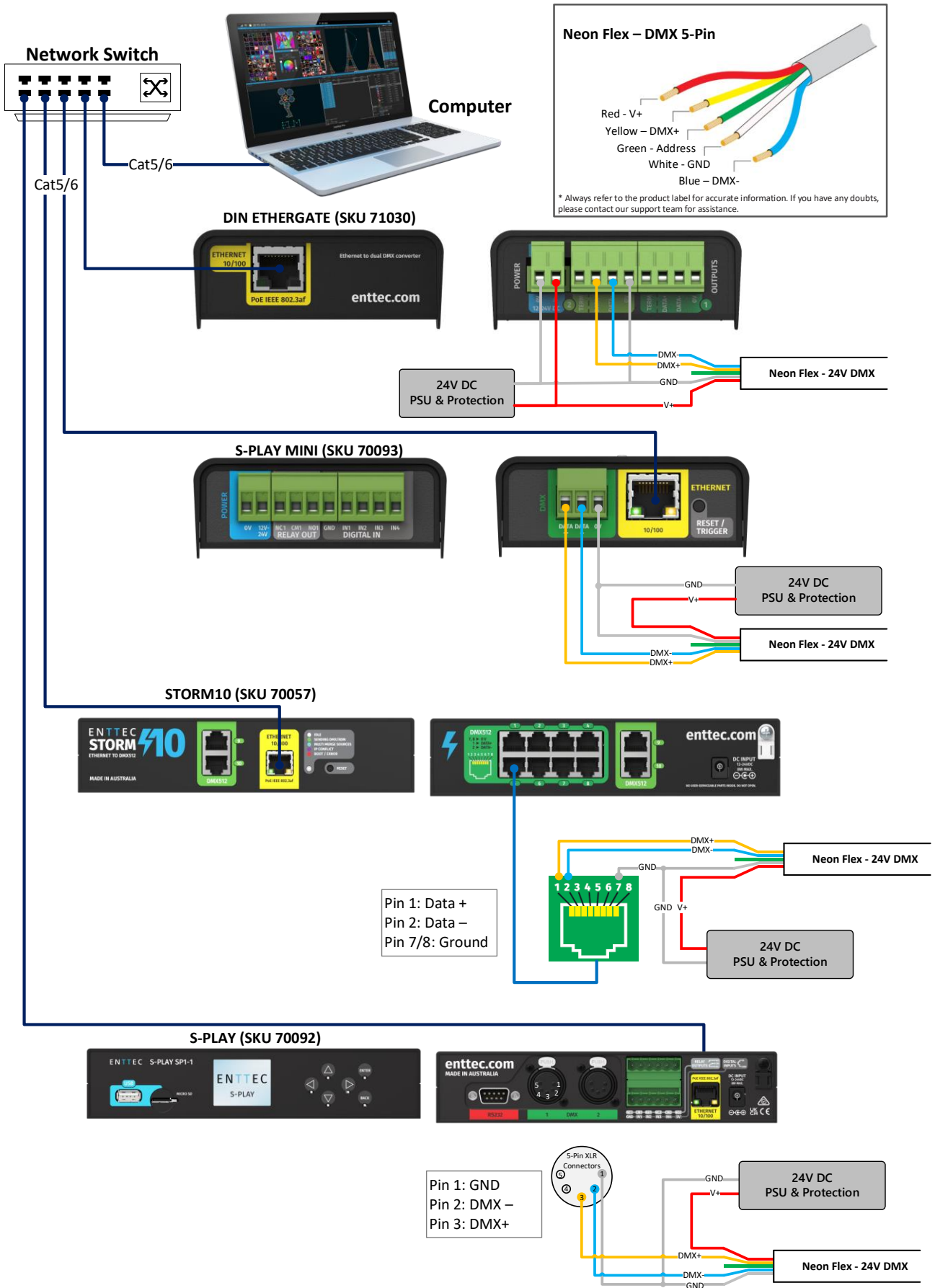

## Voltage Drop

- The longer the distance between the power source and the Neon Flex, the greater the voltage drop. Excessive voltage drop can lead to reduced brightness and colour shifting.
- The power supply should be located as close as physically possible to the beginning of the Neon Flex to minimize the effect of voltage drop.
- For optimum performance and to reduce the impact of voltage drop, ENTTEC recommend the use of multiple smaller DC power supplies at the beginning of each run of Neon Flex, instead of a low quantity of high-capacity power supplies with longer connection cables.
- Power injector cable can be ordered separately for mid power injection.
- Power supply unit is not supplied with the product. ENTTEC recommend IP67 rated or higher power supplies where applicable to your installation requirement.
- If you are concerned about voltage drop and the impact on your installation, contact the ENTTEC team or your reseller.
- The maximum run length of the customisable Neon Flex is an essential factor to consider for installations in terms of voltage drop.
- Refer datasheet or consult local distributor for max run length of each Neon Flex variant.



## Control Channels

- Each RGBW pixel of DMX controllable Neon Flex consumes the equivalent of 4 DMX channels of data.
- The hard upper limit to the number of Neon Flex you can run from one data feed can be calculated by dividing the maximum number of data channels per output of the ENTTEC controller by the DMX channel footprint of the Neon Flex.

Protocol	Channel Footprint			
Channel	1	2	3	4
DMX RGBW	Red	Green	Blue	White



## Mounting Installation

Neon Flex is an incredibly durable product; however, it must be installed following the provided picture guide. It is essential to have at least two people during the installation process to support the product at various locations as shown in the guide. It is crucial to exercise caution during installation and ensure that the bending radius of the Neon Flex is not exceeded.

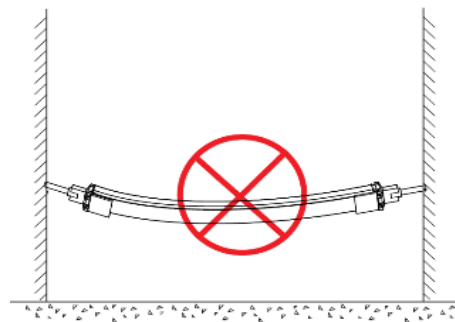
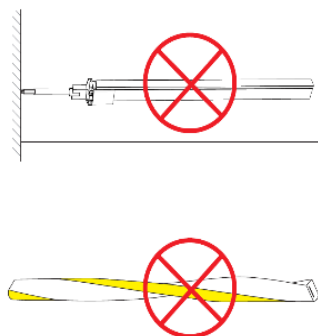
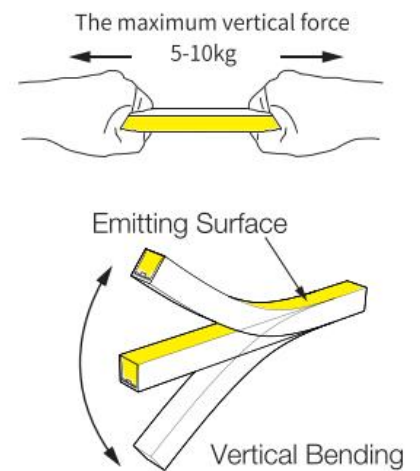
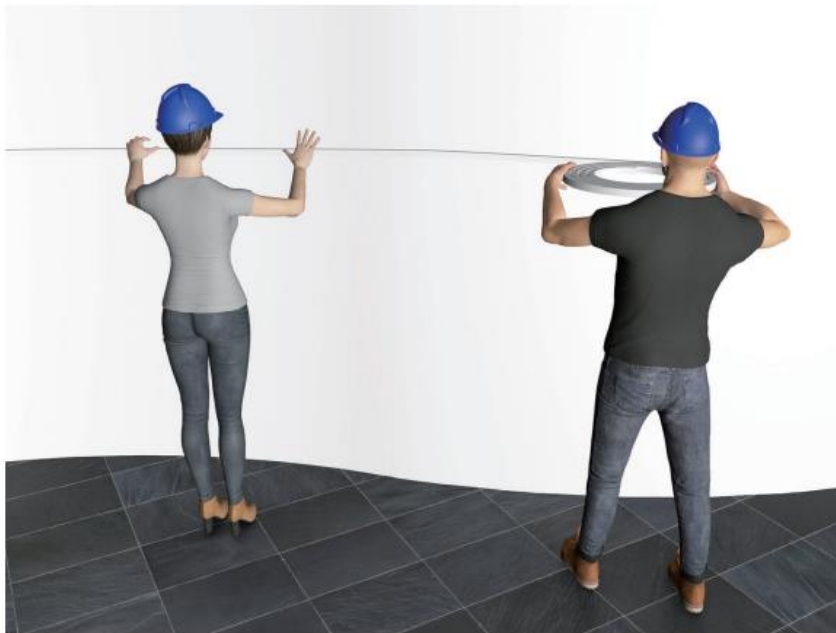
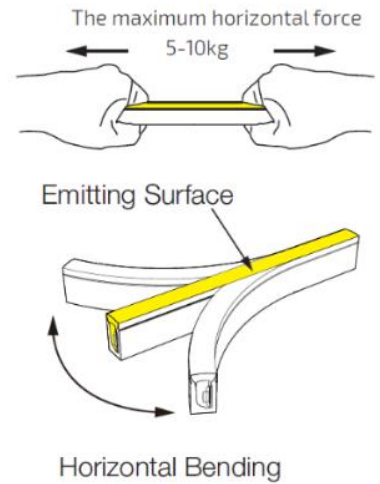
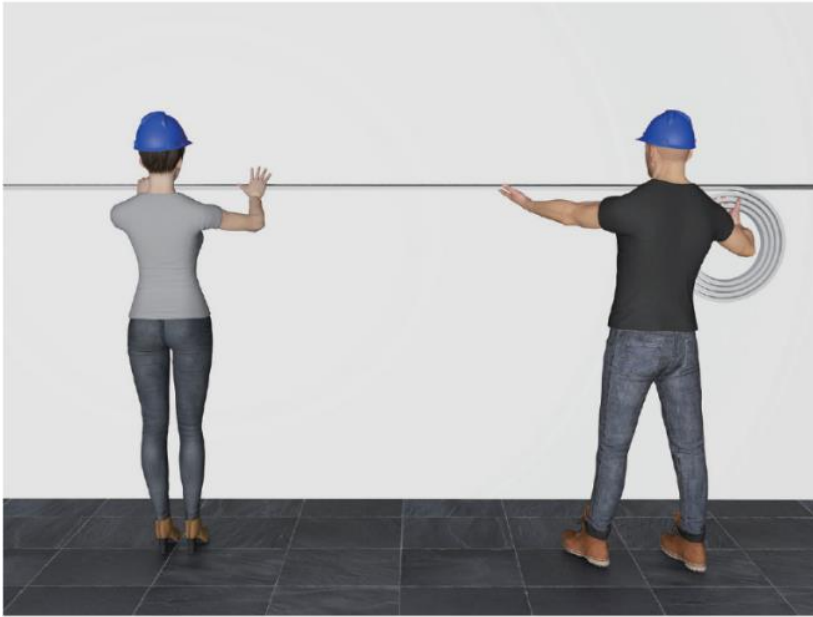

- Install Neon Flex within the specified temperature range to ensure proper bonding and flexibility. Operating outside this range may compromise performance.
- Do not use staples, nails, or any other sharp objects that may damage the silicone insulation when securing the product.
- Always use ENTTEC mounting accessories for mounting installation. Mounting accessories order information can be found at the end of the document and the product datasheet.
- Install the screw into position and make sure that the screw head is flush or recessed below the base of the aluminium profile.

### Required Screw Dimension

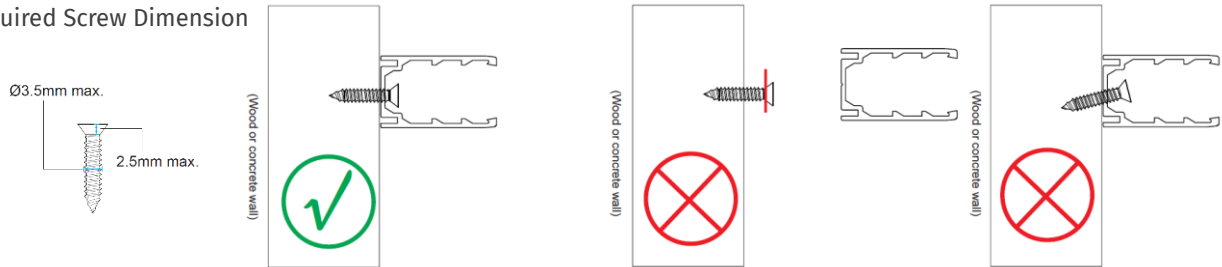

- Ensure that the mounting accessories are properly aligned and that the joint is smooth and seamless. Any displacement of the profiles can result in incorrect bending of the product, which may cause damage over time.

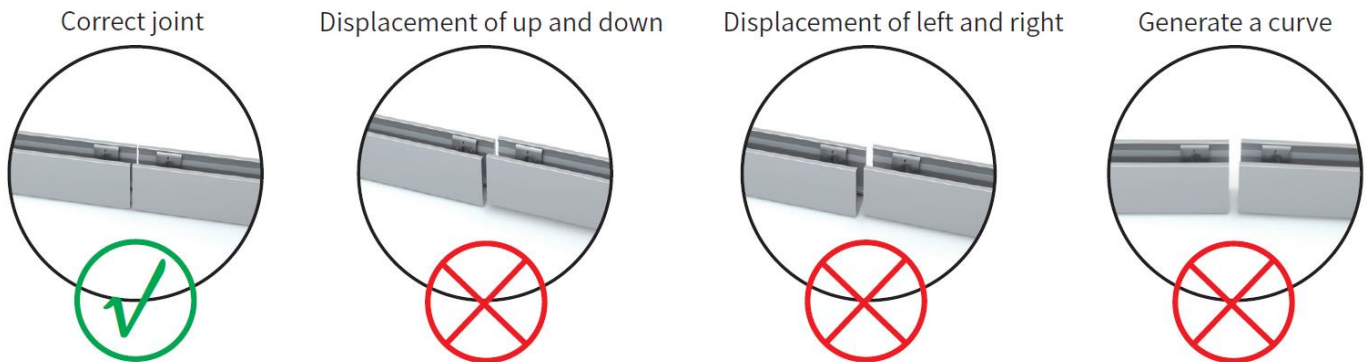

- Mounting accessories are available in different lengths to accommodate various installation needs. When cutting aluminium accessories, use appropriate tools while prioritizing safety. Ensure that the cutting surface is neat and smooth to prevent any damage to the product's finish.
- Avoid using glues and resins as fixing agents. The use of glues and resins may void the warranty unless explicitly specified otherwise.
- Maintain a minimum distance of 10mm between the aluminium mounting piece and the end cap or connectors. This spacing ensures proper installation and functionality.

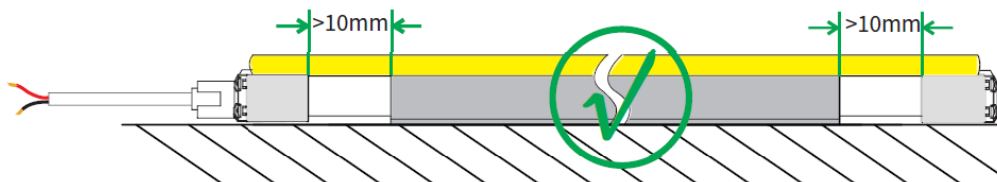

- When inserting the Neon Flex into the mounted aluminium channel, ensure that it is inserted in the correct direction. Incorrect installation may result in light failure or malfunction.



- To maintain the waterproof performance of the connector, it is important to avoid bending the Neon Flex against the light terminal. Make sure to keep a minimum distance of 100mm before shaping the Neon Flex. This will help prevent any potential damage or compromise to the waterproof seal of the connector.

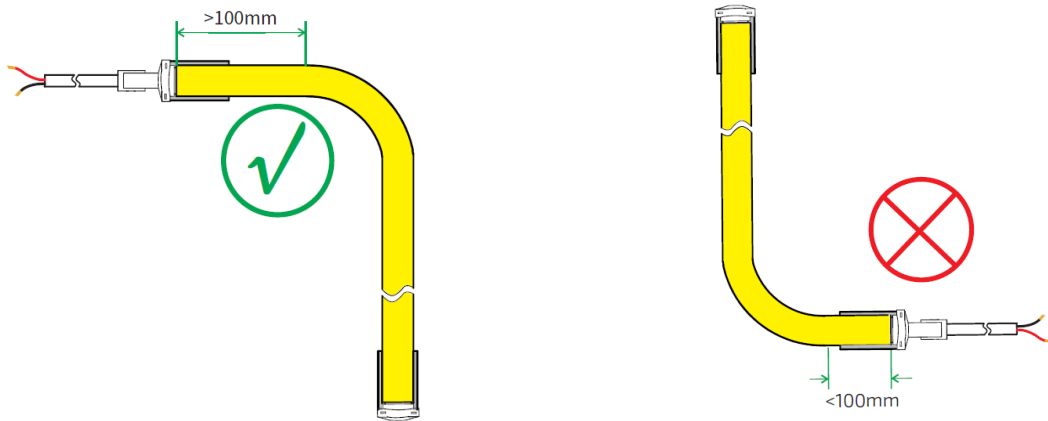

- Ensure that the feeding cable does not bear any force and allow for a 10mm lead with a loose configuration. This will help prevent any strain or stress on the cable, ensuring optimal performance and longevity.

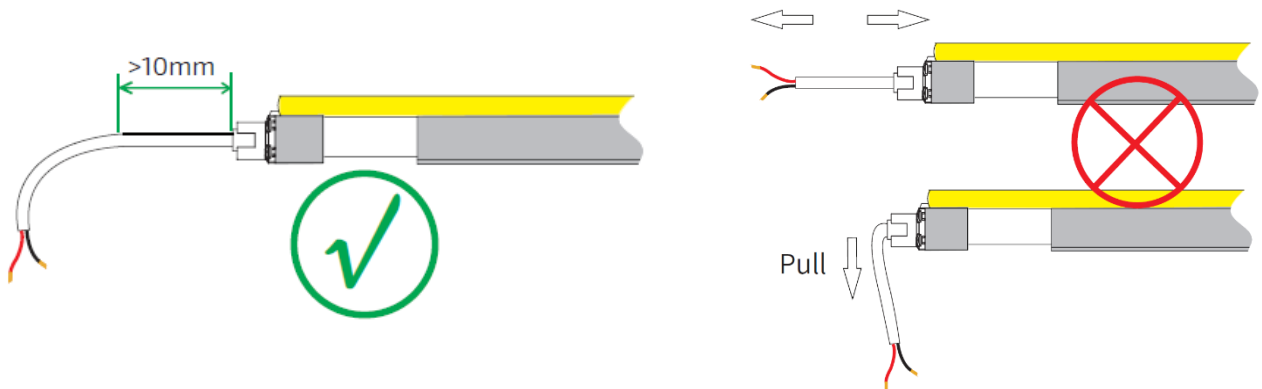

- Use an IP-rated waterproof junction box to mount the cable junction in outdoor applications for a hermetic enclosure and added protection.

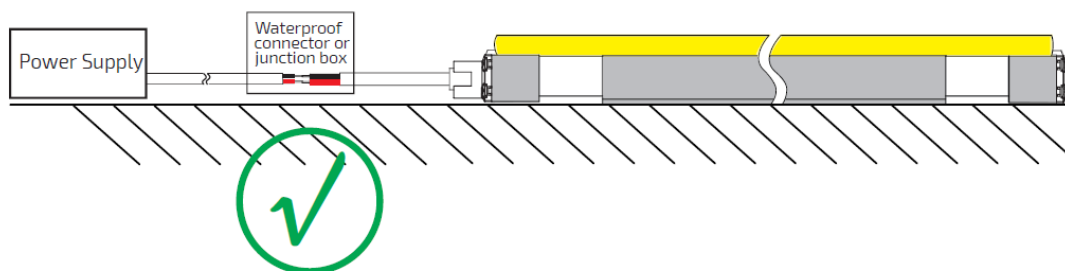

- Each fixing option serves a specific purpose, but if there is any uncertainty, it is recommended to contact technical support for further assistance.

## Servicing, Inspection & Maintenance



- **Servicing, inspection & maintenance should only be carried out by qualified technicians familiar with all safety information within this document and the Neon Flex system.**
- **Neon Flex and accessories have no user serviceable parts. If your installation has become damaged, parts should be replaced.**
- **Power down the entire system and ensure a method is in place to stop the system from becoming energized during Servicing, Inspection & Maintenance.**

Key areas to examine during inspection:

- Ensure all connectors are mated securely and show no sign of damage.
- Ensure all connectors show no sign of corrosion.
- Ensure all cabling has not obtained physical damage or been crushed.
- Ensure all Neon Flex and accessories are secured to the surface and have been installed in accordance with the guidelines set out within the installation guide.
- Check for dust or dirt build-up on the Neon Flex System and schedule cleaning if necessary. – Dirt or dust buildup can limit the ability of the Neon Flex system to dissipate heat and can lead to damage.
- If deemed necessary for a Neon Flex or accessory to be replaced, it should be removed in a reverse order to installation as defined in this guide.
- The replacement strip or accessory should be an appropriate size and be installed in accordance with all steps within the installation guide.
- To order replacement parts contact your reseller or ENTTEC directly.

## Cleaning

Dust and dirt buildup can limit the ability of the Neon Flex system to dissipate heat resulting in damage. It's important that the Neon Flex system is cleaned in a schedule fit for the environment it is installed within to ensure maximum product longevity.

Cleaning schedules will vary greatly depending on the operating environment of your Neon Flex. Generally, the more extreme the environment, the shorter the interval between cleanings.



- **Before cleaning, power down the system and ensure a method is in place to stop the system from becoming energized until cleaning is complete.**
- **Do not use abrasive, corrosive or solvent-based cleaning products on a Neon Flex system.**
- **Do not spray Neon Flex or accessories with a high-pressure water jet.**

To clean an ENTTEC Neon Flex system, use low-pressure compressed air to remove dust, dirt and loose particles. If deemed necessary, wipe the Neon Flex with a damp microfiber cloth.

A selection of environmental factors that may increase demand for frequent cleaning include:

- Use of stage fog, smoke or atmospheric devices.
- High airflow rates (i.e. in close proximity to air conditioning vents).
- High pollution levels or cigarette smoke.
- Airborne dust (from building work, the natural environment or pyrotechnic effects).
- If any of these factors are present, inspect all elements of the system soon after installation to see whether cleaning is necessary, then check again at frequent intervals. This procedure will allow you to determine a reliable cleaning schedule for your installation.

## Ordering Information

### Neon Flex

Product	SKU
Neon Flex	73060

Please refer to the datasheet or contact the ENTTEC team to discuss your customisation needs.

### Neon Flex Accessories

Product	SKU
Aluminium Mounting Accessory - Straight Linear (S1&S3)	1000mm – 73061
Aluminium Mounting Accessory – Curved (S1&S3)	500mm – 73062
	1000mm – 73063
Aluminium Mounting Accessory - Straight Linear (S2&S4)	1000mm – 73072
Aluminium Mounting Accessory – Curved (S2&S4)	1000mm – 73073
Plastic Mounting Accessory - Straight Linear (S5)	1000mm – 73074
Plastic Mounting Accessory – unit (S5)	30mm – 73075
5Pin DMX – Power Injector Connector	73068
5Pin DMX – Male Connector with cable (2m)	73069
5Pin DMX – Female Connector with Cable (2m)	73070
5Pin DMX – Extension Cable (2m)	73071

Please contact the ENTTEC team to discuss the customisation options available.

# enttec.com

MELBOURNE AUS / LONDON UK / RALEIGH-DURHAM USA / DUBAI UAE

*Due to constant innovation, information within this document is subject to change.*