

ENTTEC



EMU Hardware

70681

User Manual



ENTTEC's touring-grade USB to DMX/Art-Net interface delivers real-time lighting control for EMU software.

Content

Safety.....	2
Electrical safety.....	2
System Planning and Specification.....	2
Protection from Injury During Installation	3
Installation Safety Guidelines	3
Hardware Feature	4
Physical Dimensions	4
Mounting Method	4
DMX Connector	5
Ethernet RJ45.....	5
Footswitch and MIDI	5
LED Status Indicator	5
Wiring Diagram.....	5
Setup Guide	6
Functional Feature	7
Configuration Software – ENTTEC EMU.....	7
Device Discovery.....	8
Configuration Options	8
Connecting Footswitch or MIDI.....	8
Connecting ENTTEC Lighting Controller.....	9
Firmware Update	10
Factory Reset.....	10
Servicing, Inspection & Maintenance.....	10
Cleaning.....	11
Package Contents.....	11
Ordering Information.....	11

Safety



Ensure you are familiarized with all key information within this guide and other relevant ENTTEC documentation before specifying, installing, or operating an ENTTEC device. If you are in any doubt about system safety, or you plan to install ENTTEC device in a configuration that is not covered within this guide, contact ENTTEC or your ENTTEC supplier for assistance.

ENTTEC's return to base warranty for this product does not cover damage caused by inappropriate use, application, or modification to the product.

Electrical safety



- This product must be installed in accordance with applicable national and local electrical and construction codes by a person familiar with the construction and operation of the product and the hazards involved. Failure to comply with the following installation instructions may result in death or serious injury.
- Do not exceed the ratings and limitations defined in the product datasheet or this document. Exceeding can cause damage to the device, risk of fire and electrical faults.
- Ensure that no part of the installation is or can be connected to power until all connections and work is complete.
- Before applying power to your installation, ensure your installation follows the guidance within this document. Including checking that all power distribution equipment and cables are in perfect condition and rated for the current requirements of all connected devices and factor in overhead as well as verifying that it is appropriately fused and voltage is compatible.
- Remove power from your installation immediately if accessories power cables or connectors is in any way damaged, defective, shows signs of overheating or are wet.
- Provide a means of locking out power to your installation for system servicing, cleaning and maintenance. Remove power from this product when it is not in use.
- Ensure your installation is protected from short circuits and overcurrent. Loose wires around this device whilst in operation, this could result in short circuiting.
- Do not over stretch cabling to the device's connectors and ensure that cabling does not exert force on the PCB.
- Do not 'hot swap' or 'hot plug' power to the device or its accessories.
- Do not connect any of this device's V- (GND) connectors to earth.
- Do not connect this device to a dimmer pack or mains electricity.

System Planning and Specification



- To contribute to an optimal operating temperature, where possible keep this device out of direct sunlight.
- Any twisted pair, 120ohm, shielded EIA-485 cable is suitable to transmit DMX512 data. The DMX cable should be suitable for EIA-485 (RS-485) with one or more low capacitance twisted pairs, with overall braid and foil shielding. Conductors should be 24 AWG (7/0.2) or larger for mechanical strength and to minimize volt drop on long lines.
- A maximum of 32 devices should be used on a DMX line before re-generating the signal using a DMX buffer/ repeater / splitter.
- Always terminate DMX chains using a 120Ohm resistor to stop signal degradation or data bounce-back.
- The maximum recommended DMX cable run is 300m (984ft). ENTTEC advises against running data cabling close to sources of electromagnetic interference (EMF) i.e., mains power cabling / air conditioning units.
- This device has an IP20 rating and is not designed to be exposed to moisture or condensing humidity.

- Ensure this device is operated within the specified ranges within its product datasheet.

Protection from Injury During Installation



- Always work with a plan of the installation that respects all system limitations as defined within this guide and product datasheet.
- Note the serial number of each EMU HARDWARE and add it to your layout plan for future reference when servicing.
- All network cabling should be terminated with an RJ45 connector in accordance with the T-568B standard.

Installation Safety Guidelines



- The device is convection cooled, ensure it receives sufficient airflow so heat can be dissipated.
- Do not cover the device with insulating material of any kind.
- Do not operate the device if the ambient temperature exceeds that stated in the device specifications.
- Do not cover or enclose the device without a suitable and proven method of dissipating heat.
- Do not install the device in damp or wet environments.
- Do not modify the device hardware in any way.
- Do not use the device if you see any signs of damage.
- Do not handle the device in an energized state.
- Do not crush or clamp the device during installation.

Hardware Feature

- Touring-grade hardware interface expertly designed for ENTTEC's EMU Software offering easy-to-use sound-to-light integration.
- 3-pin/5-pin XLR provide a combined DMX output of 512 channels.
- EtherCON Ethernet RJ45 with DHCP server supporting ENTTEC lighting controllers for multi-universe lighting output.
- ¼" TRS jack for footswitch/MIDI input to control lighting states in EMU Software.
- Type-C USB connection to PC for power and data transfer.
- Opto-isolation protects your computer from stray voltage or phantom power mistakenly connected to the DMX line
- Convenient mounting holes for secure DIN Clip installation.
- Customisable aesthetic status LED.
- TS35 DIN mount (using provided DIN Clip accessory)

Physical Dimensions

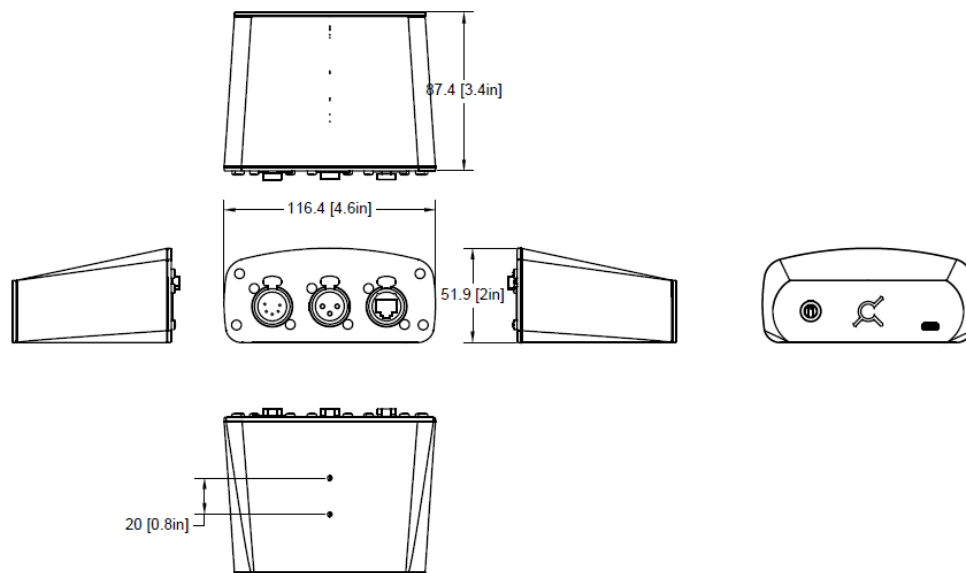

Mounting Method

The EMU Hardware supports DIN rail mounting. To install, attach the DIN rail clip using the screws provided in the product packaging. Once secured, mount the product onto a suitable TS35 rail for installation.



Note: The mounting accessory have been designed to hold the weight of the EMU HARDWARE only, excess force caused by cable strain can cause damage.

DMX Connector

The EMU Hardware features both 3-Pin and a 5-Pin Female XLR DMX ports for a combined 512 channels of DMX512 output.

- PIN1: GND (V-)
- Pin 2: Data -
- Pin 3: Data +
- Pin 4: NC (5-Pin XLR only)
- Pin 5: NC (5-Pin XLR only)



Ethernet RJ45

The EMU Hardware features an EtherCON Ethernet RJ45 port with DHCP server. This allows users to quickly create a lighting control network on the go, without the need for complex network setups.

Note: DO NOT connect EMU Hardware’s Ethernet RJ45 to other DMX ports or any established Ethernet network. Doing so may cause DHCP conflicts or permanent damage to the EMU Hardware along with the connected equipment. Always verify connections before proceeding with installation.

Footswitch and MIDI

The EMU Hardware features a standard ¼" stereo jack, compatible with any MIDI device or non-latching footswitch.

Footswitch: Both normally-open and normally-closed switches are supported. Only passive pedals that short the tip & sleeve (Switch A) or ring & sleeve (Switch B) should be used. A mono ¼" jack for single-switch connections is also supported.

Proprietary pedals with non-standard jacks or additional signals should be avoided.

MIDI: EMU Hardware automatically detects whether a Type A or Type B wired MIDI connection is used and works seamlessly with both.

¼" TRS Jack	Footswitch	MIDI – Type A	MIDI – Type B
Sleeve	GND	Shield	Shield
Ring	Switch B	Source	Sink
Tip	Switch A	Sink	Source



LED Status Indicator

The EMU Hardware LED status display various statuses by default:

LED Colour	Status
Blue	Starting-up
White	Idle
Green	Data received
Red and White	Error/Powered without USB data
Red	Error/Boot
Cyan	MIDI Input
Yellow	Footswitch Input



Additionally, the LED indicator is customizable, allowing you to select your preferred colour for the status display. However, the red error status feedback will always remain visible regardless of your chosen settings.

Wiring Diagram

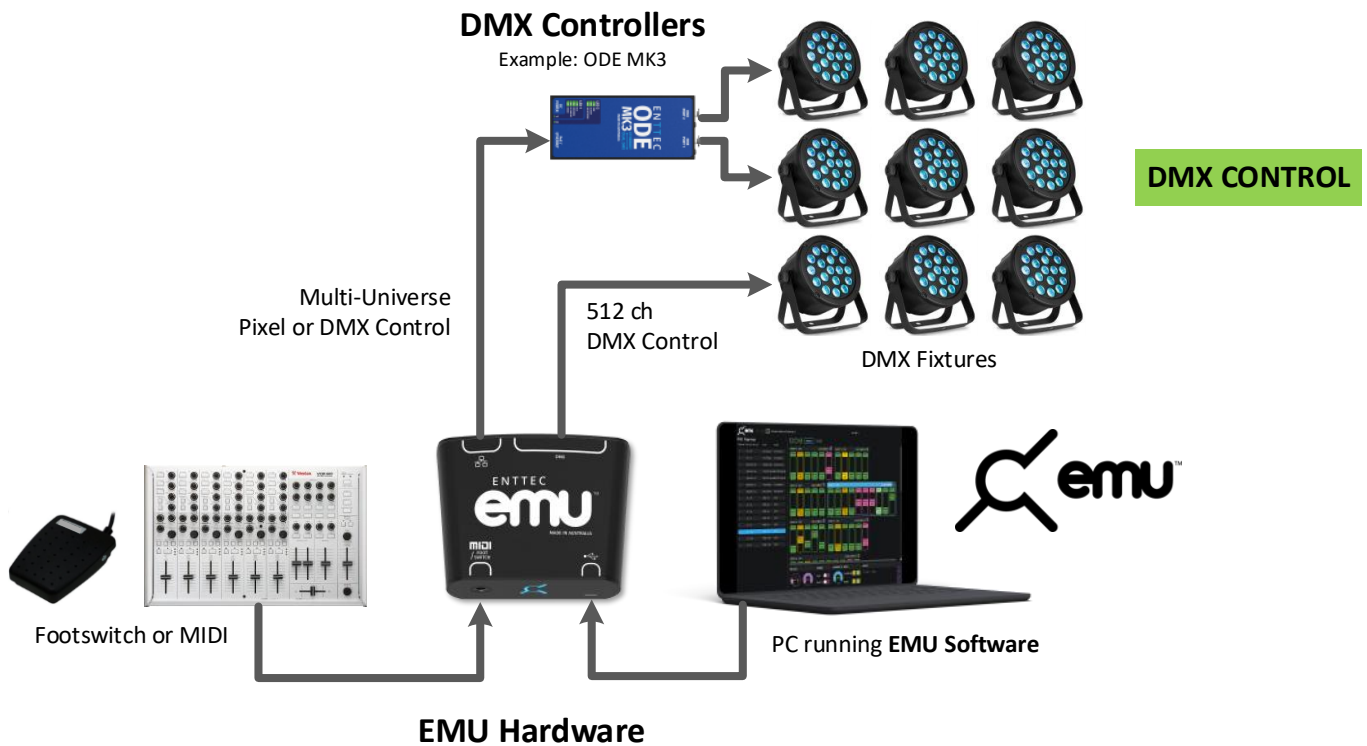

Setup Guide

1. Install and configure the ENTTEC EMU Software on your Windows™ or Mac™ computer.
2. Connect the EMU Hardware to your computer with the data-grade USB Type-C cable provided.
3. Connect the DMX output (either 3 pin or 5 pin) of the EMU Hardware to the “DMX IN” XLR socket on your first light fixture.
4. Connect “DMX OUT” of the first fixture to “DMX IN” of the next fixture. Continue connecting all remaining light fixtures together in a daisy-chain connection.
5. Connect a DMX terminator plug to the DMX OUT of the last fixture.
6. Send data to your DMX fixtures.
7. Optionally connect a footswitch/MIDI to the 1/4” jack input on the EMU Hardware for direct control.
8. Optionally directly connect EMU hardware to a compatible ENTTEC lighting controller or use a network switch to link multiple compatible devices for multi-universe lighting control setup.

Note:

- Use data-grade USB Type-C cables with 5 cores which supports both power and data transmission; USB phone chargers may not be suitable for data transfer.
- Use data-grade DMX cables to connect your lighting rig. Microphone cables are not designed for digital signals and can cause issues, especially over long distances.
- Always use a DMX terminator plug in the last fixture of the chain to prevent signal issues, particularly when using long DMX cables.

Functional Feature

- Controls any DMX-512 compatible light fixture, including classic dimmer packs, LED fixtures, and intelligent lighting (e.g. scanners & moving heads)
- Supports EMU Software multi-universe output to compatible ENTTEC lighting controllers.
- Streamlined integration with compatible ENTTEC controllers, featuring device discovery and auto-configuration through EMU Software.
- Plug-and-play setup, delivering stunning lighting effects on the go.
- Customisable LED indicator colours enhancing user experience.

Configuration Software – ENTTEC EMU

To configure the EMU Hardware, you need the ENTTEC EMU Software.

Visit the ENTTEC website to download a free version of the EMU Software, which includes basic functionalities to help users explore the platform. The software provides a comprehensive setup and management suite for the EMU Hardware, featuring:

- **Device Discovery:**

EMU Software detects the connected EMU Hardware and auto-configure the compatible lighting devices linked via the Ethernet port, streamlining the configuration process.

- **Configuration:**

The user-friendly interface supports configuration of the EMU Hardware, as well as integration with Footswitch and MIDI devices for seamless control.

- **Multi-Universe Output and Patching:**

EMU Software enables multi-universe output, allowing users to patch their desired devices and universes through an intuitive interface.

- **Firmware Update:**

Easily update the firmware of EMU Hardware directly through the EMU Software to ensure optimal performance and access to the latest features.



Device Discovery

In EMU Software, navigate to the **Preferences** window. This window will appear automatically when the software is launched or can be accessed by clicking the gear icon  in the top-right corner.

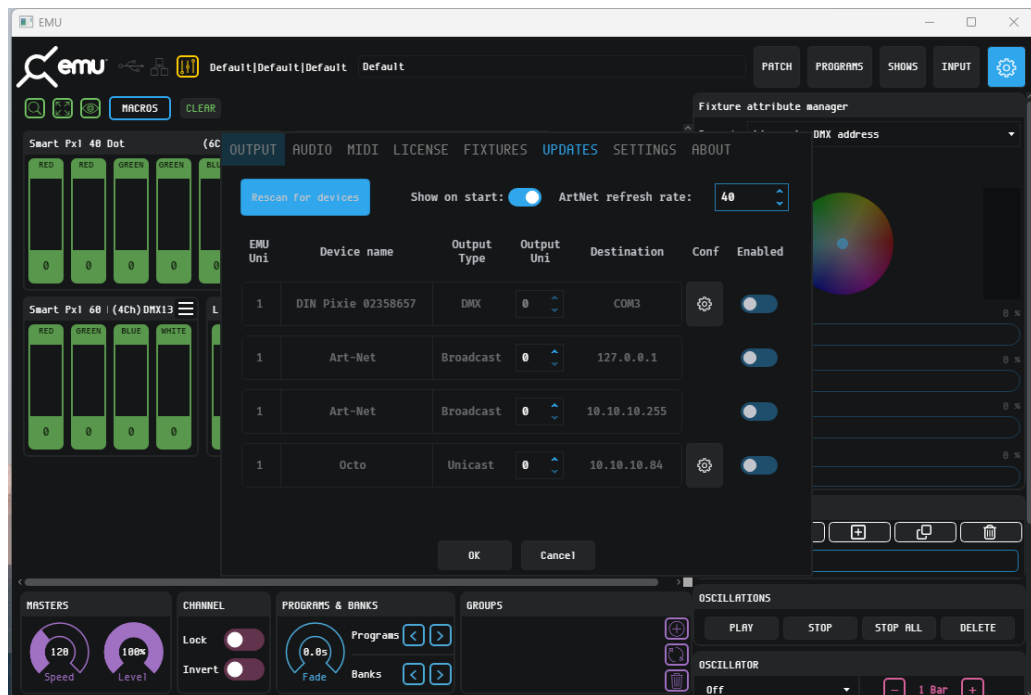

In the **Output** tab, click the **Scan for devices** button to search for any EMU Hardware connected to your computer. Once the device is detected, click the gear icon next to the device to access configuration options.

Configuration Options

The **Config** page offers detailed information on the EMU Hardware's configuration options, allowing you to customise settings:

- **Packet Refresh Rate:** Data refresh rate at 30 frames per second (fps) by default. Adjustable up to 44 fps.
- **TRS Mode:** Configurable TRS port for either Footswitch or MIDI input.
- **Status LED Colour:** Customisable for footswitch or MIDI feedback.
- **Make Parameters Default:** Resets all settings to their default values.
- **Set DMX Parameters:** Sends the configured settings to the EMU Hardware.
- **Get DMX Parameters:** Retrieves the current DMX settings from the EMU Hardware.

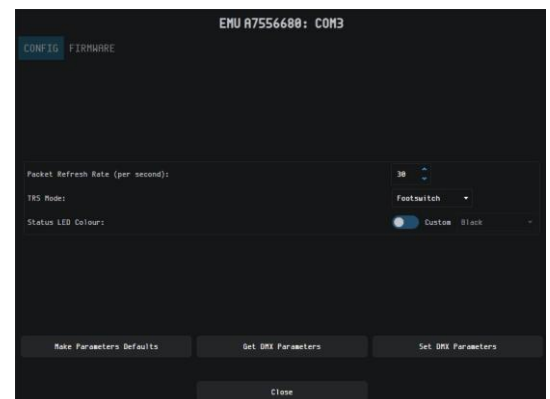

Connecting Footswitch or MIDI

Follow these steps to connect your Footswitch or MIDI device to the EMU Hardware:

1. **Set the TRS Mode:** In the EMU Software, set the TRS mode to the desired option: either Footswitch or MIDI.
2. **Save Settings:** Click 'Set DMX Parameters' to apply and save your configuration.
3. **Connect the Device:** Plug your Footswitch or MIDI device into the TRS port on the EMU Hardware.

- Automatic Detection:** The EMU Software will automatically detect the connected device for seamless operation. When a footswitch is detected, a Footswitch Tab will appear in the EMU Software for further configuration. If MIDI is detected, navigate to MIDI tab's drop-down list and search for EMU.
- Footswitch or MIDI configuration:** see EMU Software User Manual for detailed instructions.

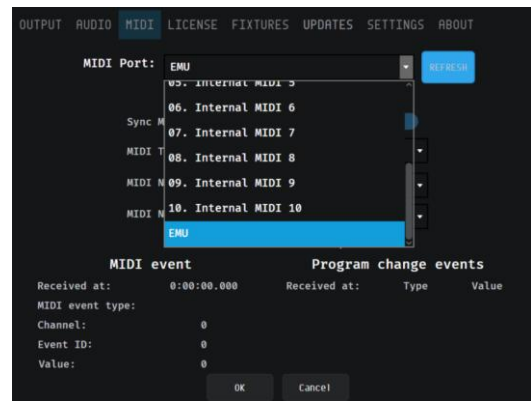
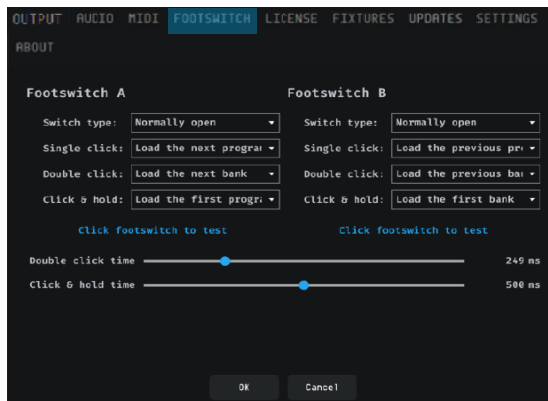

Connecting ENTTEC Lighting Controller

EMU Hardware featuring RJ45 ethernet port supporting connection to other Art-Net controllers. The EMU Software will discover connected devices and allow integration of compatible ENTTEC lighting controllers.

Follow these steps to configure and manage your devices:

- Connect Devices:** Set up all devices according to the Wiring Diagram in the user manual.
- Power On:** Ensure all devices are powered on and ready for operation.
- Scan for Devices:** In the EMU Software, click 'Scan for devices' to initiate the discovery process.
- View Discovered Controllers:** The EMU Software will display all connected ENTTEC lighting controllers linked to the EMU Hardware.

This setup supports:

- **Multi-Universe Output & Patching:** the compatible devices to work with EMU Software's multi-universe output. See EMU Software User Manual for detailed patching instructions.

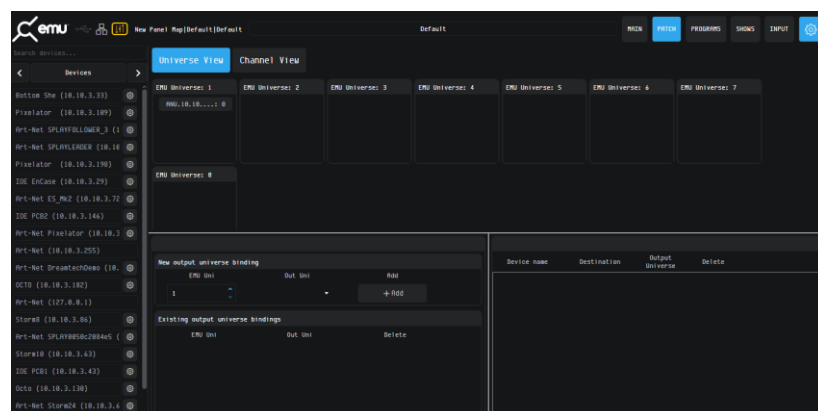

- **Plug & Play for compatible Controller:** Plug & Play for compatible ENTTEC lighting controllers auto-configured to default settings.

ODE MK3

- DHCP-enabled networks.
- DMX Out enabled.
- No RDM functionality.
- Port 1 Universe 0 and Port 2 Universe 1.

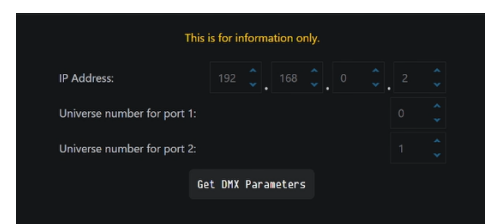

Firmware Update

The firmware update procedure can be used to:

- Update to the latest feature set.
- Reset EMU HARDWARE if it ever gets stuck or stops responding. (Eg., Error mode).

The following steps will explain the firmware update procedure:

1. Launch the EMU Software on your computer and select  of the discovered EMU Hardware from the device list.
2. either choose the default firmware from the drop-down list or click Choose Firmware to locate a file from another source.
3. After selecting the firmware, click Update Firmware and allow the process to complete. Ensure the USB cable remains connected during the update. Progress will be displayed on the screen.
4. Once the update is finished, close the page. The firmware update is now complete.

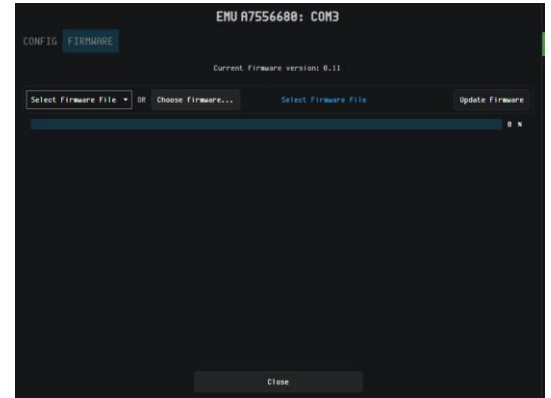

Note: Please ensure your EMU Software is updated to the latest version.

Factory Reset

In certain scenarios, such as when the device is not discoverable or has unstable firmware, you may need to perform a factory reset directly from the device. Follow these steps:

1. Use a DMX-TRS adaptor to connect the 3-Pin XLR DMX port and the TRS port.
2. Use a USB Type-C cable to connect the EMU Hardware to your computer. The LED will flash red, indicating it is in boot mode.
3. Launch the EMU Software on your computer and select  of the discovered EMU Hardware from the device list.
4. The EMU Software will prompt you to the firmware tab, where you can perform firmware updates or other maintenance tasks.

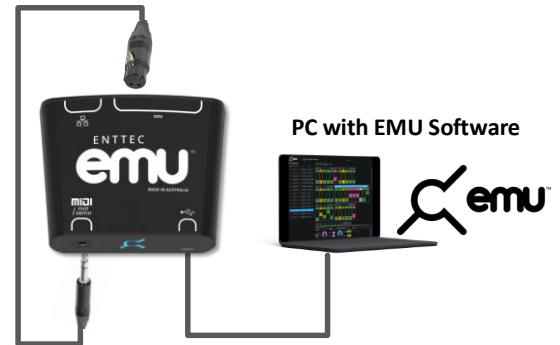

Servicing, Inspection & Maintenance



- **The device has no user serviceable parts. If your installation has become damaged, parts should be replaced.**



- **Power down the device and ensure a method is in place to stop the system from becoming energized during servicing, inspection & maintenance.**

Key areas to examine during inspection:

- Ensure all connectors are mated securely and show no sign of damage or corrosion.
- Ensure all cabling has not obtained physical damage or been crushed.
- Check for dust or dirt build up on the device and schedule cleaning if necessary.
- Dirt or dust buildup can limit the ability for a device to dissipate heat and can lead to damage.
- The replacement device should be installed in accordance with all steps within the installation

guide. To order replacement devices or accessories contact your reseller or message ENTTEC directly.

Cleaning

Dust and dirt build up can limit the ability for the device to dissipate heat resulting in damage. It's important that the device is cleaned in a schedule fit for the environment it is installed within to ensure maximum product longevity.

Cleaning schedules will vary greatly depending on the operating environment. Generally, the more extreme the environment, the shorter the interval between cleanings.



- **Before cleaning, power down your system and ensure a method is in place to stop the system from becoming energized until cleaning is complete.**
- **Do not use abrasive, corrosive, or solvent-based cleaning products on a device.**
- **Do not spray the device or accessories. The device is an IP20 product.**

To clean an ENTTEC device, use low-pressure compressed air to remove dust, dirt, and loose particles. If deemed necessary, wipe the device with a damp microfiber cloth.

A selection of environmental factors that may increase the need for frequent cleaning include:

- Use of stage fog, smoke or atmospheric devices.
- High airflow rates (i.e., in close proximity to air conditioning vents).
- High pollution levels or cigarette smoke.
- Airborne dust (from building work, the natural environment or pyrotechnic effects).

If any of these factors are present, inspect all elements of the system soon after installation to see whether cleaning is necessary, then check again at frequent intervals. This procedure will allow you to determine a reliable cleaning schedule for your installation.

Package Contents

- EMU HARDWARE
- DIN mounting clip + screws
- 1M USB 2.0 Type C -> Type C cable

Ordering Information

For further support and to browse ENTTEC's range of products visit the [ENTTEC website](#).

Item	Part No.
EMU HARDWARE	70681

enttec.com

MELBOURNE AUS / LONDON UK / RALEIGH-DURHAM USA / DUBAI UAE

Due to constant innovation, information within this document is subject to change.